



THIS FITNESS AREA & EQUIPMENT IS DESIGNED FOR AGES 13+ YEARS

IT IS THE MANUFACTURERS OPINION AND INTENT THAT THE USE AND LAYOUT OF THESE COMPONENTS CONFORM WITH THE AMERICAN SOCIETY FOR TESTING AND MATERIALS (ASTM) STANDARD ASTM F3101

THE EQUIPMENT SHOWN IS TO BE CONSIDERED FITNESS EQUIPMENT ONLY. APPROPRIATE SIGNAGE INDICATING THIS IS STRONGLY RECOMMENDED. OUTDOOR FITNESS EQUIPMENT SHALL NOT BE PLACED WITHIN DEFINED CHILDREN'S PLAYGROUND AREAS AND SHALL BE SEPARATED FROM THE USE ZONES FOR PLAYGROUND EQUIPMENT BY FENCING, MOUNDS, PATHWAYS, LANDSCAPING OR OTHER BARRIERS

IT IS THE MANUFACTURERS OPINION THAT THIS PLAY AREA DOES CONFORM TO THE A.D.A. ACCESSIBILITY STANDARDS, ASSUMING AN ACCESSIBLE PROTECTIVE SURFACING IS PROVIDED, AS INDICATED, OR WITHIN THE ENTIRE USE ZONE.

CHOOSE A PROTECTIVE SURFACING MATERIAL THAT HAS A CRITICAL HEIGHT VALUE TO MEET THE MAXIMUM FALL HEIGHT FOR THE EQUIPMENT (REF. ASTM F3101 STANDARD CONSUMER SAFETY PERFORMANCE SPECIFICATION FOR OUTDOOR FITNESS EQUIPMENT FOR PUBLIC USE, SECTION 7.16 CURRENT REVISION). THE SUBSURFACE MUST BE WELL DRAINED. IF THE SOIL DOES NOT DRAIN NATURALLY IT MUST BE TILED OR SLOPED 1/8" TO 1/4" PER FOOT TO A STORM SEWER OR A "FRENCH DRAIN".

THIS CONCEPTUAL PLAN WAS BASED ON INFORMATION AVAILABLE TO US. PRIOR TO CONSTRUCTION, DETAILED SITE INFORMATION INCLUDING SITE DIMENSIONS, TOPOGRAPHY EXISTING UTILITIES, SOIL CONDITIONS, AND DRAINAGE SOLUTIONS SHOULD BE OBTAINED, EVALUATED, & UTILIZED IN THE FINAL DESIGN. PLEASE VERIFY ALL DIMENSIONS OF PLAY AREA, SIZE, ORIENTATION, AND LOCATION OF ALL EXISTING UTILITIES, EQUIPMENT, AND SITE FURNISHINGS PRIOR TO ORDERING.

DESIGNED BY:

COPYRIGHT: 6/26/19  
 LANDSCAPE STRUCTURES, INC.  
 601 7th STREET SOUTH - P.O. BOX 198  
 DELANO, MINNESOTA 55328  
 PH: 1-800-328-0035 FAX: 1-763-972-6091

No.	Revision/Issue	Date

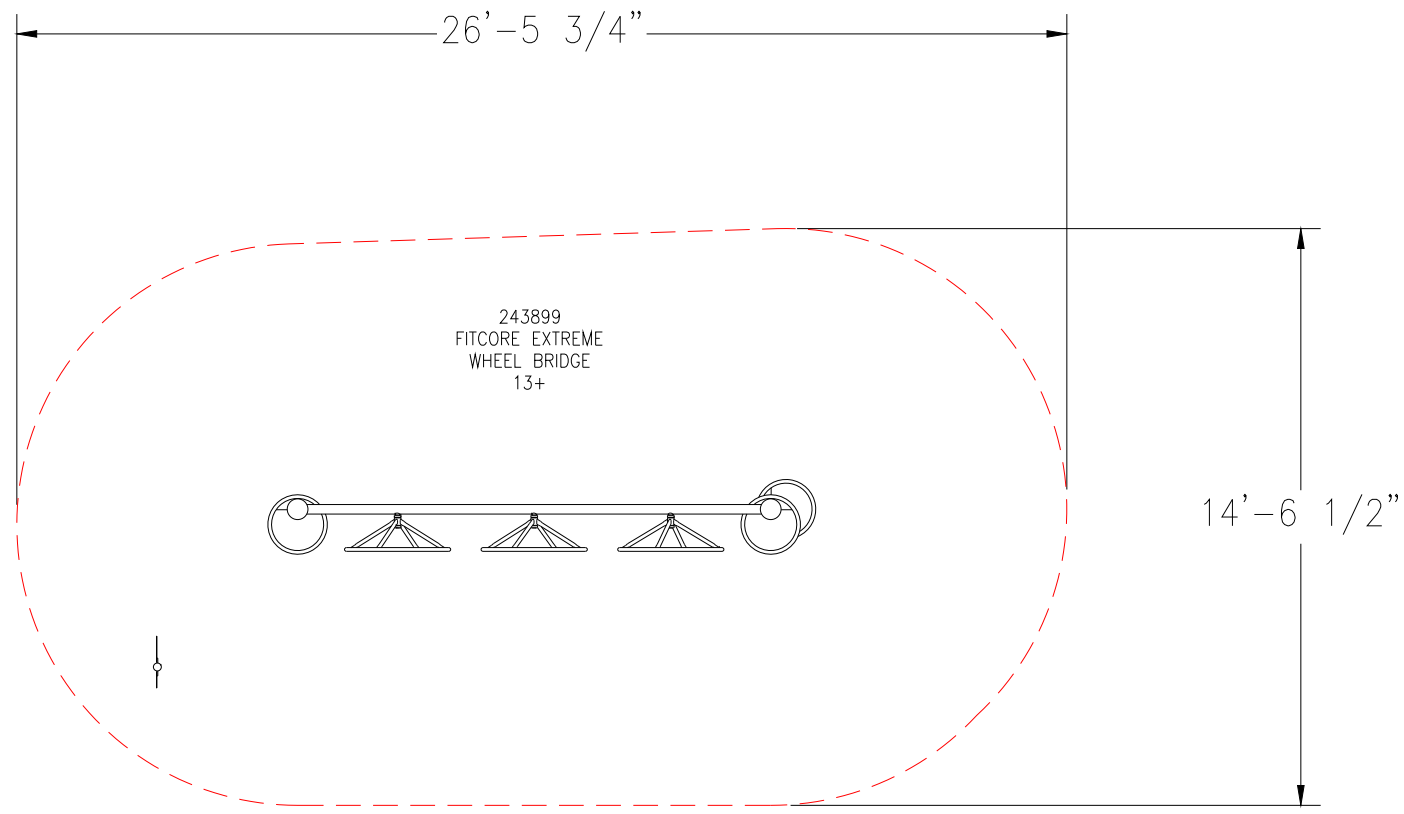

Freestanding Play  
(13+ years)

Max Fall Height: 120 inches

TOTAL SQUARE FOOTAGE  
336 SQ.FT.

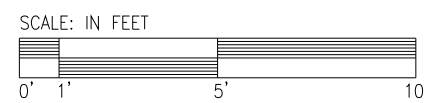

Design  
6193

Landscape  
Structures

Freestanding

6193

